

# Submarine

by KOMINAMI Hiroshi

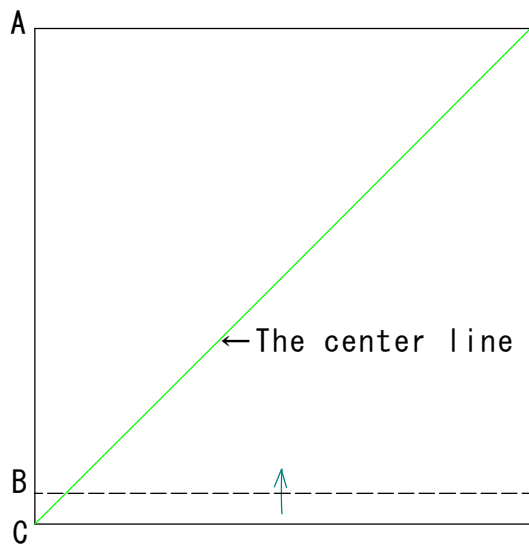

[1] The paper should be a square.

Dark gray or black paper is favorable.

$AC : BC \doteq 16 : 1$

Turn over

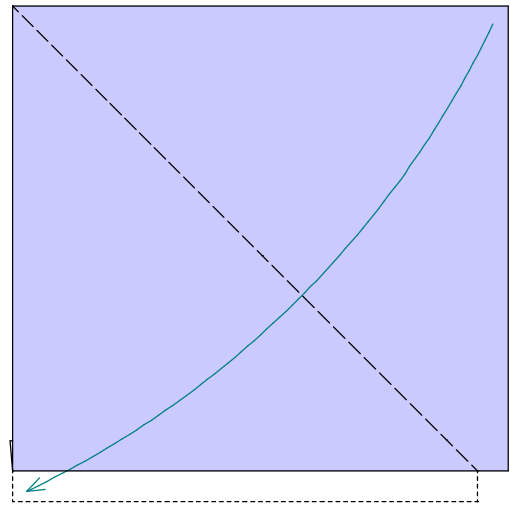

[2]

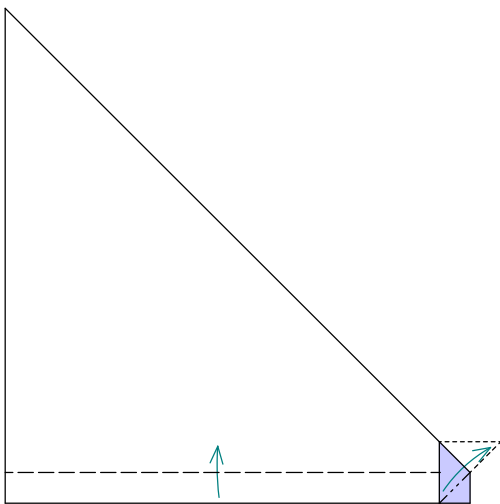

[3] At first, let's make a tail fin (rudder).

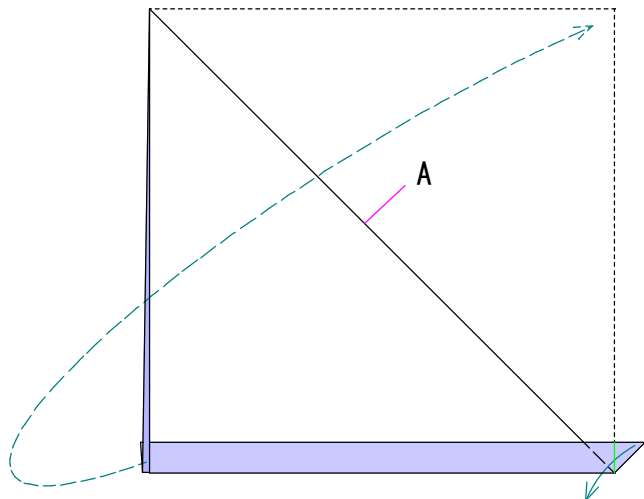

[4] Unfold line A (= the center line).

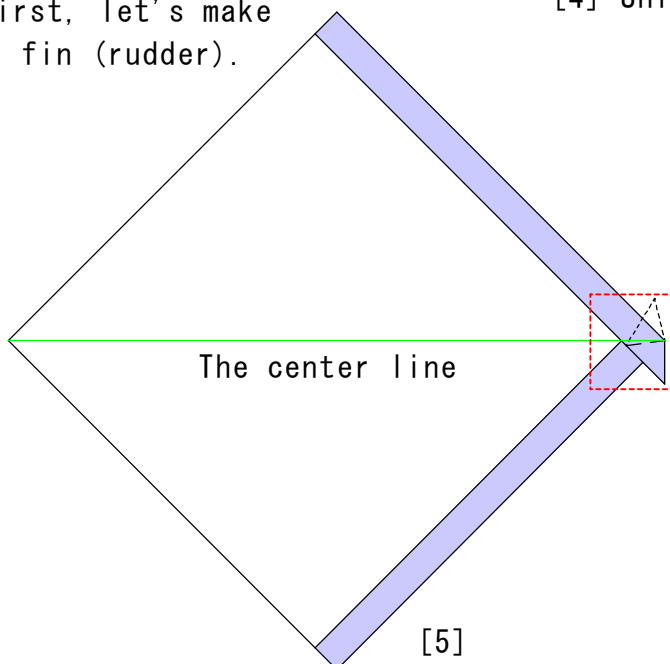

[5]

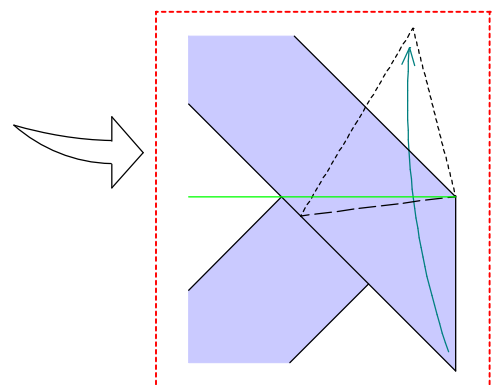

[6]

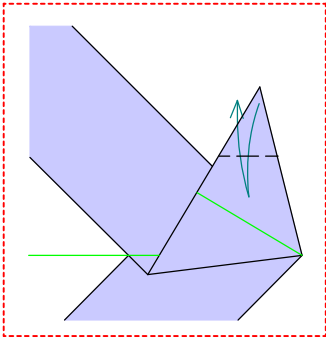

[7]

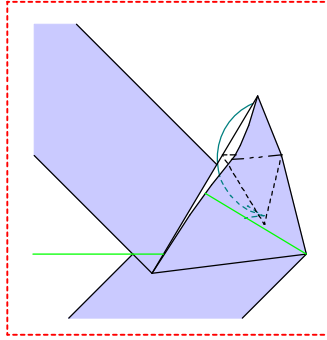

[8] To shorten the fin, insert the top into the valley.

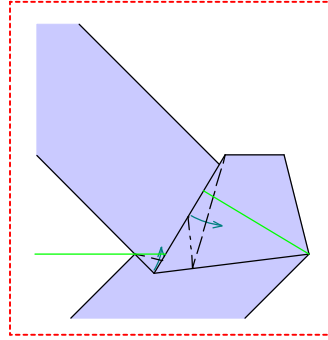

[9]

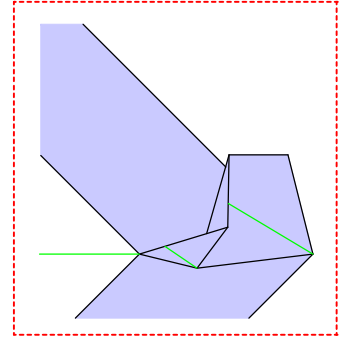

[10]

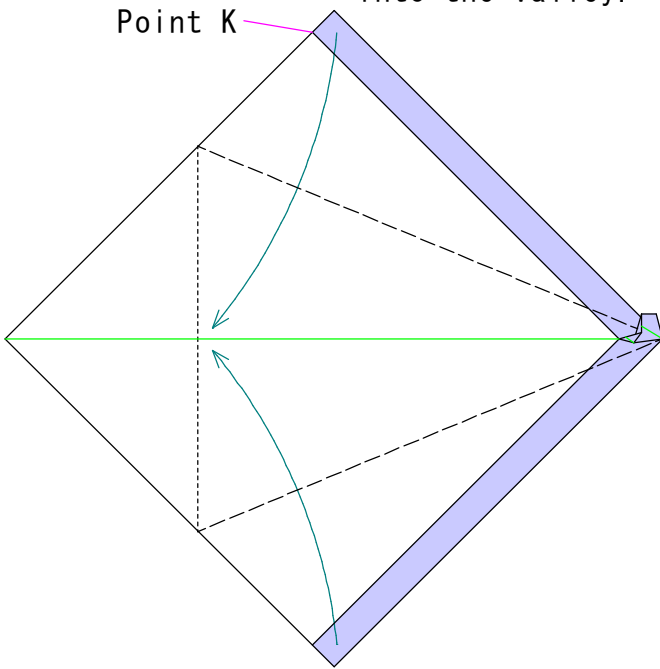

[11] Then we make the body and the sail.

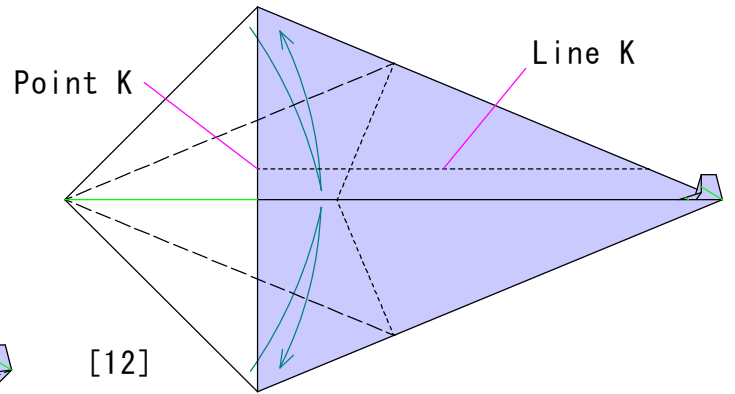

[12]

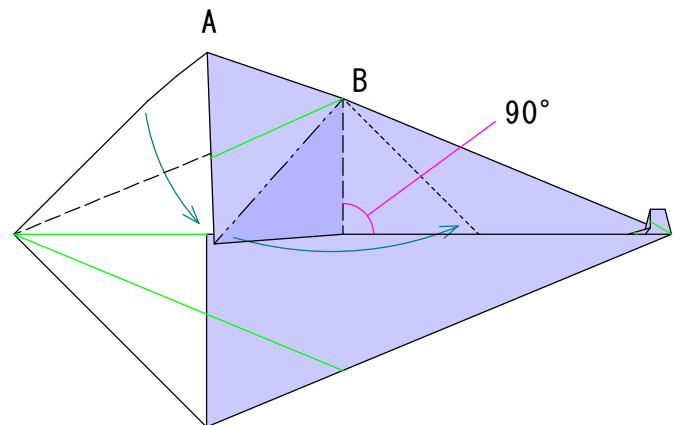

[13] Unfold line AB.

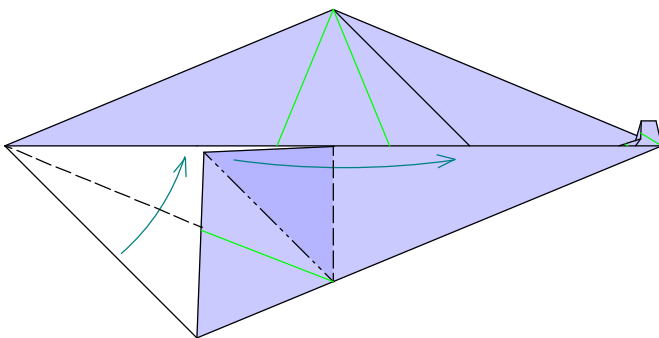

[14]

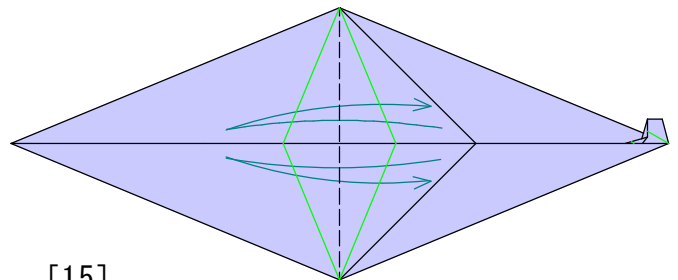

[15]

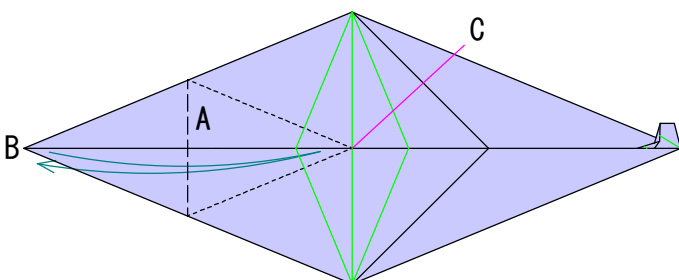

[16] Fold line A so that B meets C, then unfold.

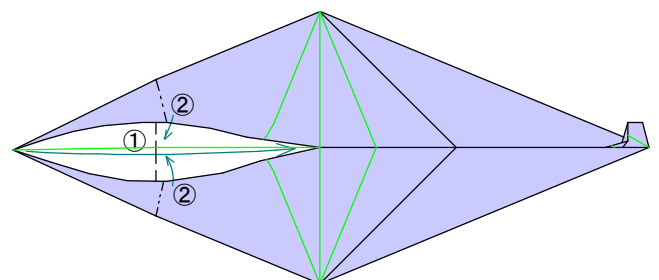

[17] Shorten the head.

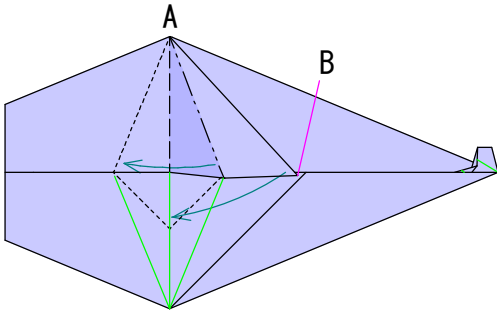

[18] Unfold line AB.

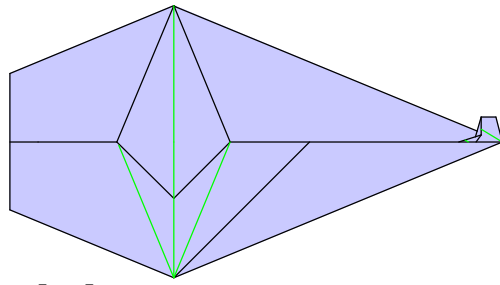

Turn over

[19] The following pictures are enlarged 1.25 times.

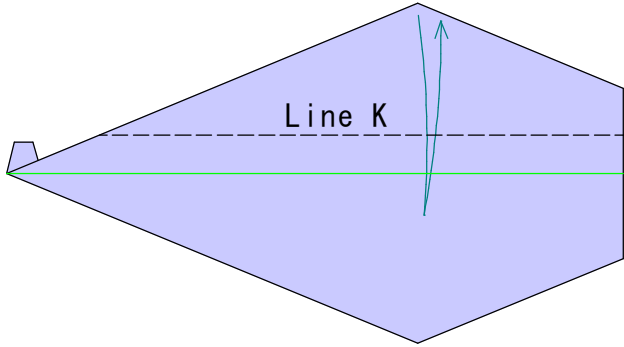

Turn over

[20] Fold along Line K (ref. [12]), and unfold.

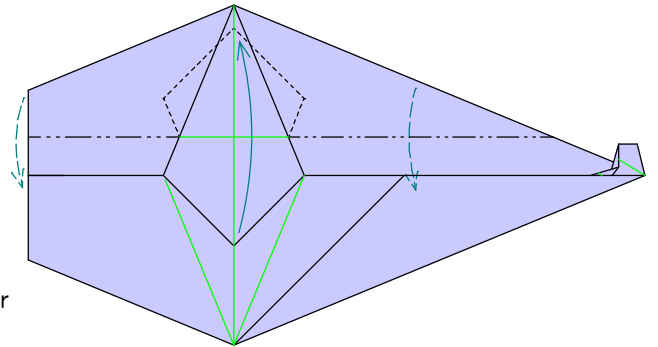

[21]

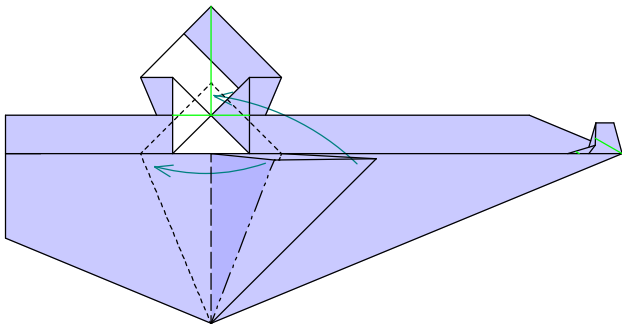

[22]

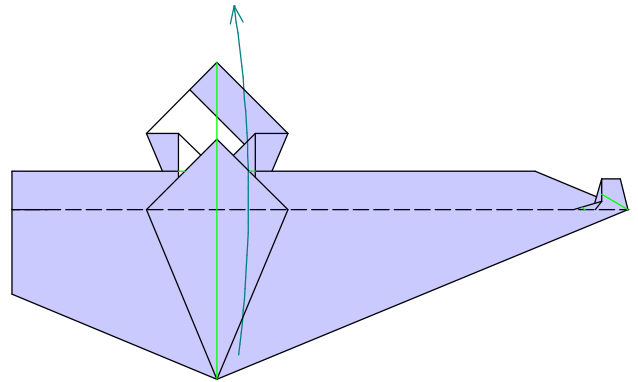

[23]

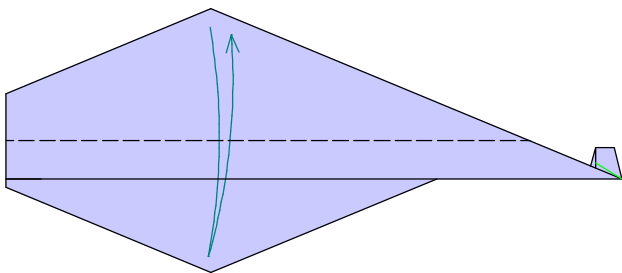

[24]

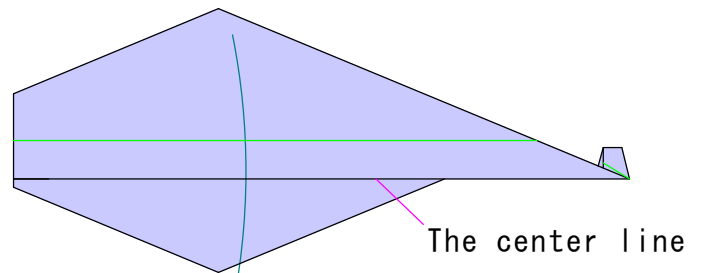

[25] Unfold the center line.

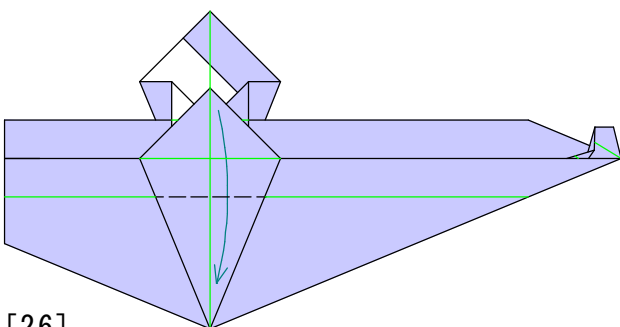

[26]

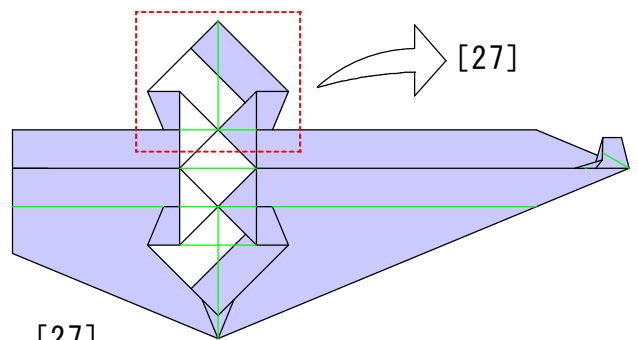

[27]

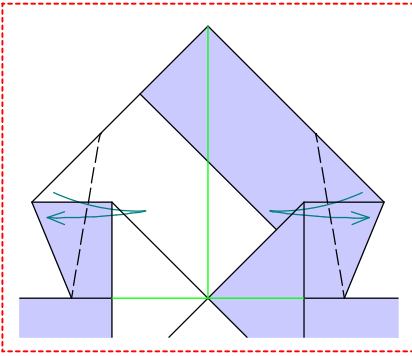

[28]

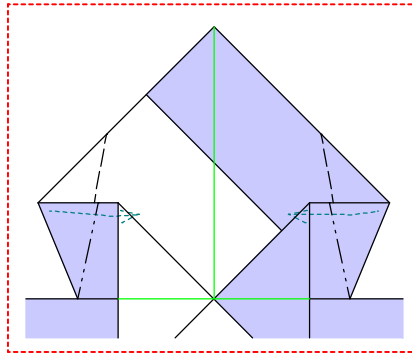

[29]

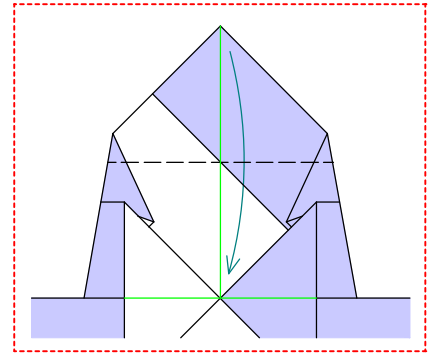

[30]

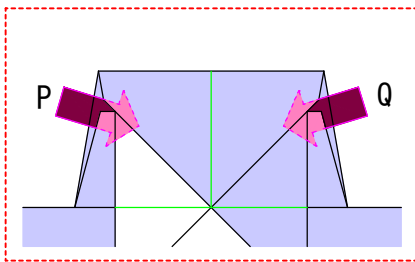

[31] Notice that we have made two pockets: pocket P and pocket Q.

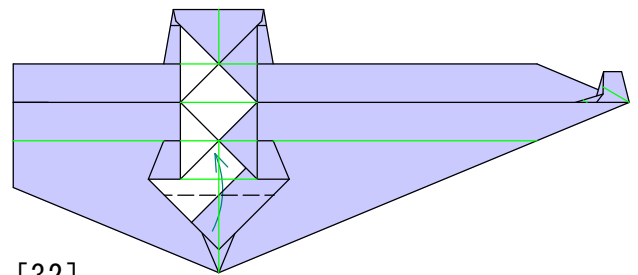

[32]

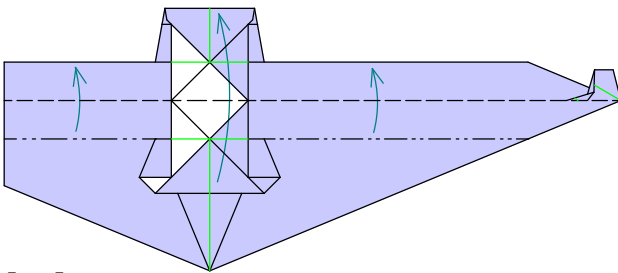

[33]

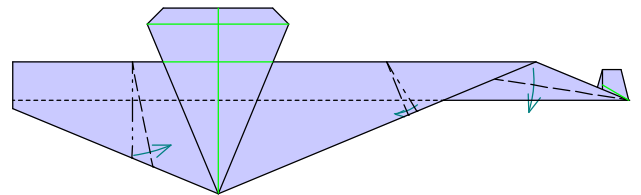

[34] Let's form the dorsal line.  
This step and the following steps should be taken symmetrically except step [43].

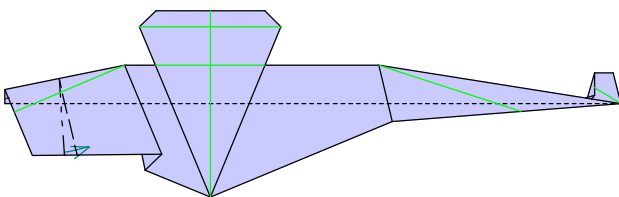

[35]

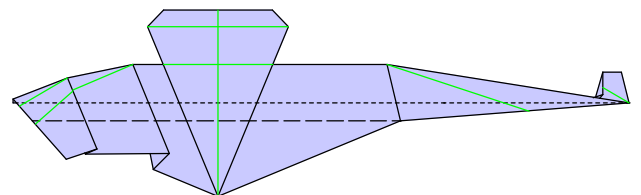

[36] Then we form the waterline.

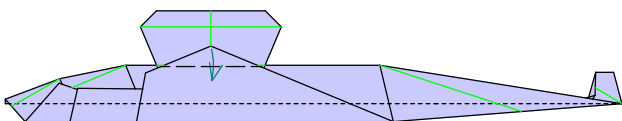

[37]

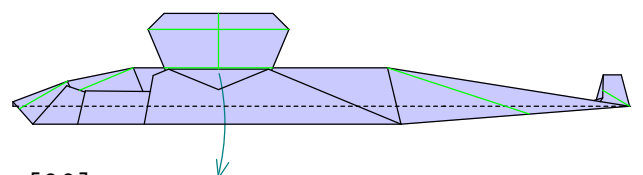

[38]

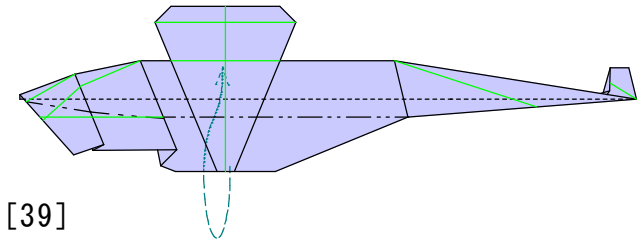

[39]

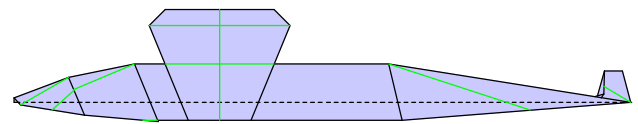

[40]

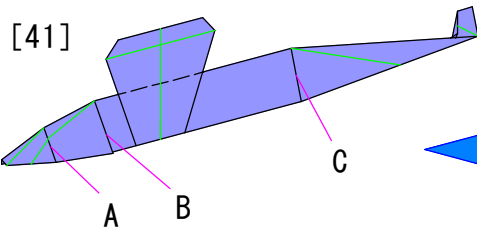

[41]

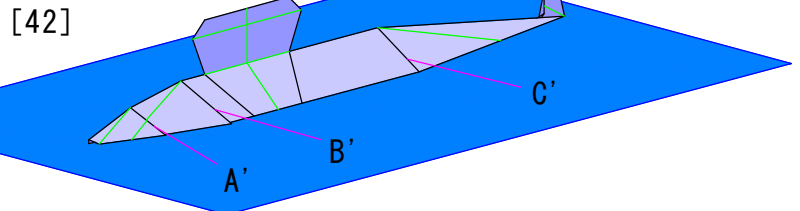

[42]

[41] - [42] Put the ship on a flat surface. Then slide tucks A, B, and C so that the lower edge (= waterline) of the ship will fit the surface.

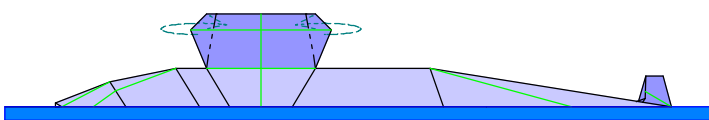

[43a]

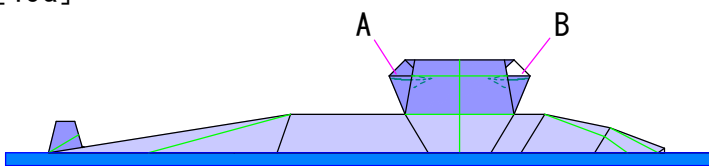

[43b] The back side of [43a].

Insert the tips A, B into the pockets Q, P (ref. [31]) respectively. This step prevents lateral separation of the sail.

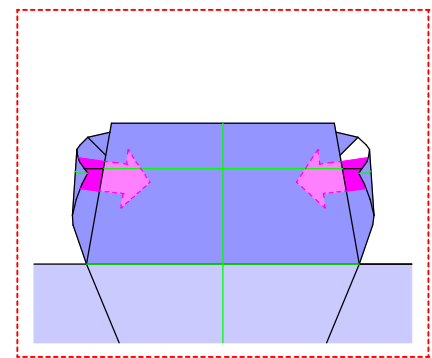

[43c]

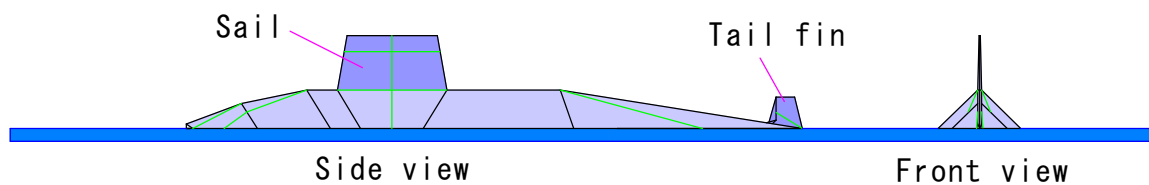

Side view

Front view

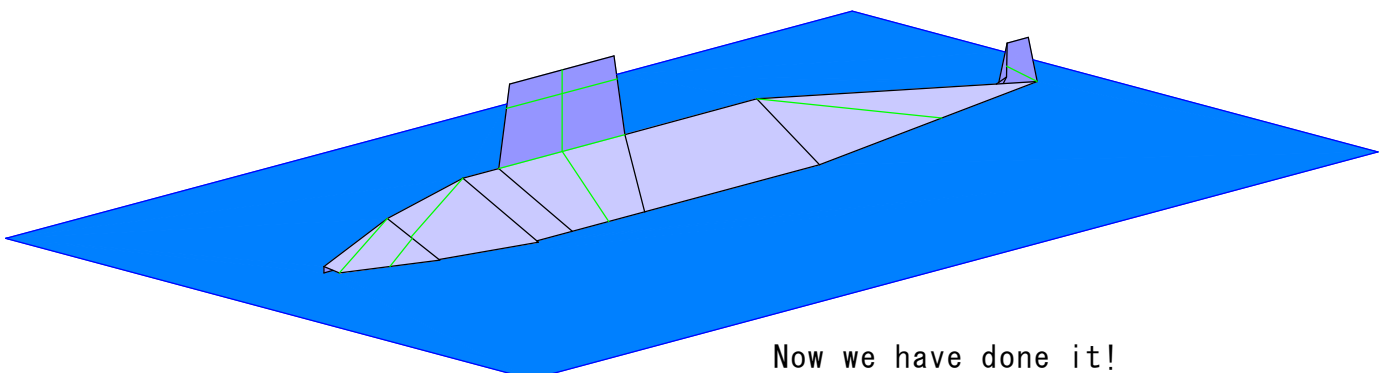

Now we have done it!